

**TRUCKS AND BUSES**



# PROFITABLE FOR LIFE.

## Eicher Pro 6019

The 18.5 Tonne GVW Truck



**EUTECH 6**



# EUTECH 6

Eicher is creating a new benchmark in the Indian commercial vehicle industry, through a revolutionary BSVI solution that combines global technology with innovative support services. This solution doesn't just make your vehicle BSVI compliant but ensures higher productivity of the truck and profitability of your business.



## Euro VI Expertise for 6 years

VECV has been manufacturing and supplying base engines to the Volvo Group since 2013. Over 1,00,000 Euro VI base engines supplied, operating in 41 countries. First to rollout BSVI CV range in India, incorporating expertise of Euro VI technology.



## Efficient EATS and engine technology

Best fluid economy: Lower fuel consumption + DEF consumption combined. Reliable EATS + engine technology tested for over 56,00,000 km. Vanadium based SCR for high reliability & low maintenance.



## Enhanced UPTIME

Eicher Uptime Centre for 24x7 support by specialists. GPS enabled service vans just a phone call away. Remote diagnostics for quick repair of BSVI vehicles.

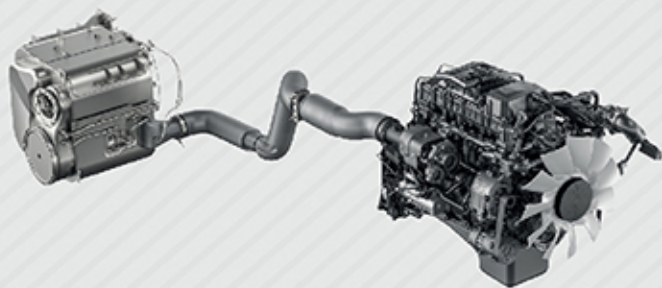

COMPACT BOX TYPE EATS FOR EFFICIENT THERMAL MANAGEMENT



The new Eicher Pro 6019 is the 18.5 Tonne GVW rigid haulage truck, powered with proven VEDX5 engine delivering the best power and torque combination in its segment. It is designed to deliver class leading performance in tough applications making Eicher Pro 6019 *Profitable for Life*.



# More Km per Litre.

The new Eicher Pro 6019 is designed to deliver best in class fuel efficiency thereby reducing the overall operational costs and increase profitability. The proven **VEDXS** engine clubbed with Volvo Group's EMS, delivers **high peak torque over a wide range of RPM**, thereby resulting in more trips with lesser fuel consumption.

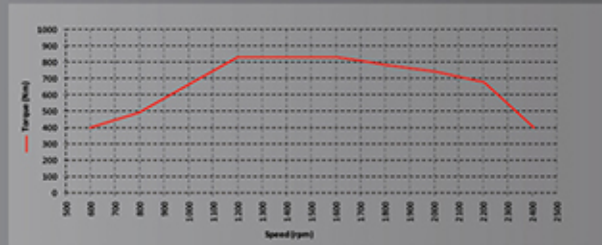
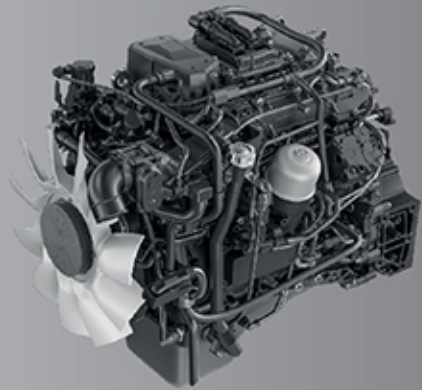

# More Trips. Extra Miles.

Robust, rigorously tested and optimized driveline delivers more power and higher torque which enables **higher productivity**. Quick gear shifts, minimal RPM and torque disruptions enable better **pick up**. High torque to weight ratio ensures **outstanding gradeability**. All this together leads to **faster turnaround** and more trips.

- » High power to weight ratio for increased load pulling ability.
- » Modular DOMEX chassis for high tensile strength.
- » Parabolic suspension with Anti Roll bar at front for better vehicle stability at sharp turns.
- » Ergonomically designed cabin for increased driver productivity.



- » Proven VEDXS CRS Engine- 210 hp @ 2200 rpm.
- » Flat torque delivery of 825 Nm over a wide rpm range (1200-1600 rpm).
- » **M Booster+** to optimize acceleration and maximize fuel efficiency.
- » First in industry **Fuel coaching** providing real time guidance for improved driver efficiency and fuel economics.
- » Energy saving components like Viscotronic fan & ESS Compressor.

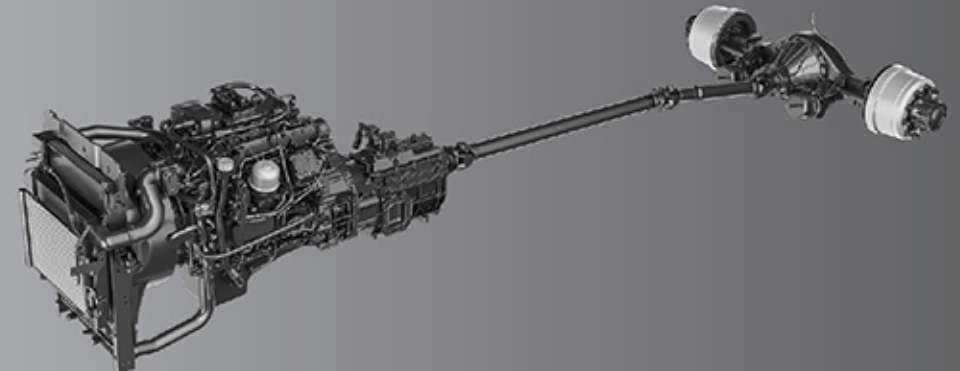

# Superior Uptime.

Higher strength and lower weight composite material derive **maximum component** life ensuring truck is on road and available to haul always. With the **fully equipped Eicher Service Network**, preventive maintenance of the truck is ensured thus delivering superior uptime.



On Board Diagnostics



ET90 6 Speed Gearbox



Bigger Crown Wheel



- » Advance on-Board Diagnostics system that displays fault indicators in the form of visual signals, messages and alarms.
- » Engine Protection System ensuring 4 way protection.
- » Exhaust brake to prevent engine over-running.
- » Longer and synchronized service intervals.

# More Comfort. Longer Drives.

Pro 6019 Cabin has been designed keeping in mind the long and tiring journeys, the drivers have to travel in. The **global cabin** provides a **comfortable workspace** that ensures they are not only comfortable, but also safe while on their long runs.

- » Sleeper cabin for better comfort.
- » Meeting AIS 029 cabin strength test.
- » Dual panel cabin for structural strength.
- » Intelligent Driver information system (IDIS) that provides truck operational parameters.
- » Tilt & telescopic power steering & 6 way adjustable seat for better driving posture
- » Cruise Control for fatigue-free driving experience.



# Lifetime Support Solutions.

Through our Lifetime Support Solutions, we ensure a seamless and hassle free experience from the time you consider buying an Eicher vehicle to the time you think of selling. Our continuously improving and holistic services will ensure higher uptime and productivity for your BSVI vehicles.

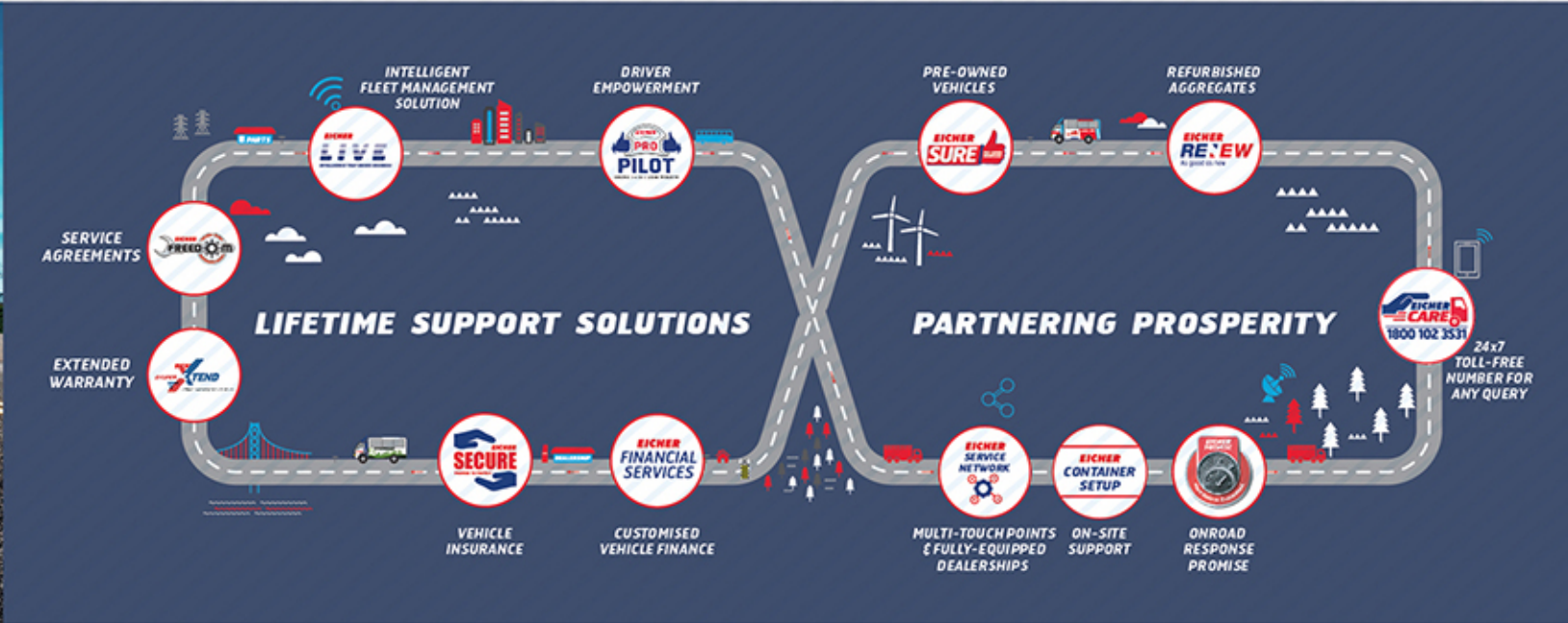

Eicher has taken a step towards achieving Superior Uptime, with a responsive attitude, that will set us apart and create a differentiated experience for our customer. With our new UPTIME CENTER and UPTIME CERTIFIED WORKSHOPS, we are now geared up with a pro- active support system for diagnostic assistance through advanced diagnostic tools.



At Uptime Certified Workshops only  
\*T&C Apply

## Model Eicher Pro 6019

GVW (kg)	18500					
Engine	VEDXS, 4 Cylinder - BSVI					
Max Power	210 hp @ 2200 rpm					
Max Torque	825 Nm @ 1200-1600 rpm					
Clutch (mm)	395					
Gearbox	ET90S6					
Rear Axle	Heavy Duty fully floating single reduction, 440 mm drive head					
FDR	4.3					
Chassis Dimensions (mm)	285x76x6					
Brakes	Dual circuit full air 'S' Cam with ABS					
Front Suspension	Parabolic					
Rear Suspension	Semi elliptic					
Cabin	Sleeper cabin					
Steering	Tilt and telescopic power steering					
Tyres	Front: 295/90R20 Rear: 10R20					
Fuel Tank (Litres)	350					
DEF Tank (Litres)	50					
Battery	24V					
Gradeability (%)	30					
Wheelbase (mm)	4300			4800		
Variants	CBC	CWC	HSD	CBC	CWC	HSD
Load body Span (mm)	5462	5890	5506	6072	6500	6111
Applications	City civic, Construction material, Truck mounted crane					

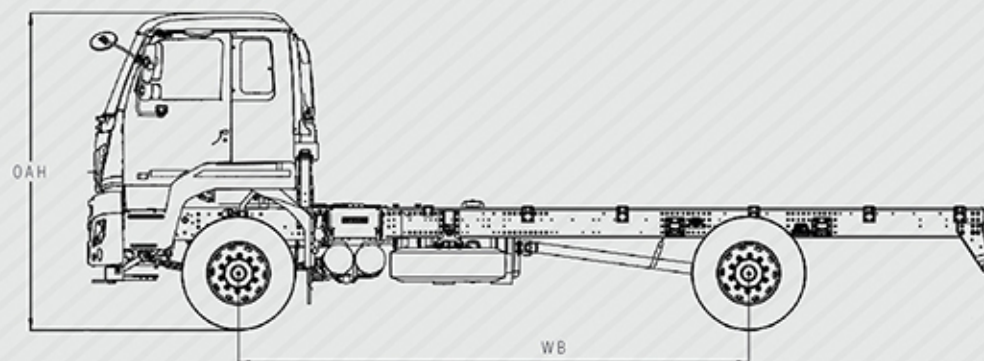
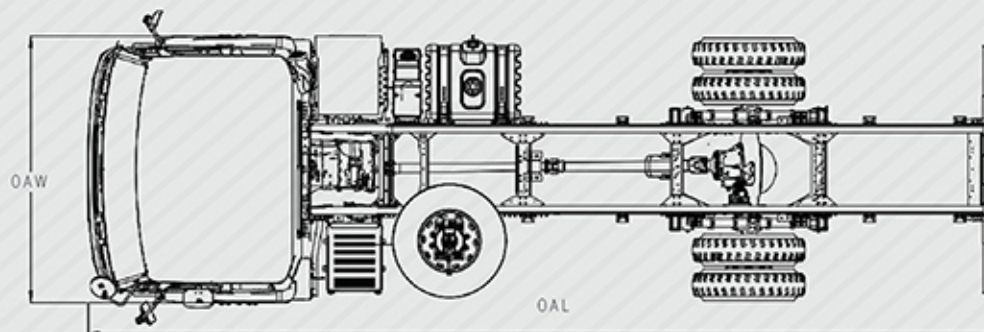

Vehicle Model	Overall Length (OAL) mm	Overall Width (OAW) mm	Overall Height (OAH) mm	Wheelbase (mm)
Pro 6019 CBC (5462mm)	7980	2510	2915	4300
Pro 6019 CBC (6072mm)	8590	2510	2915	4800



**VE COMMERCIAL VEHICLES**  
A VOLVO GROUP AND EICHER MOTORS JOINT VENTURE  
eichertrucksandbuses.com, Eicher Care- 1800 102 3531

VE COMMERCIAL VEHICLES LTD.  
Registered Address – 3rd Floor Select Citywalk,  
A -3 District Centre, Saket, New Delhi 110 107, India  
CIN – U74900DL2008PLC175032

CORPORATE ADDRESS  
Eicher Trucks & Buses  
#96, Sector – 32, Gurgaon  
122001, Haryana, India

Caution: \*do not weld or drill on chassis frame. \*Accessories, colours and features shown in pictures or elsewhere may not constitute standard fitment. \*Weight mentioned is for standard configuration with standard body sizes and will change due to optional fitments. \*as a result of continuous research and innovation carried out, specifications are merely indicative and are subject to change without notice.